

**Core Fit Reference**

**1185**

**EI-35**  
Metric

**EI-37**  
American

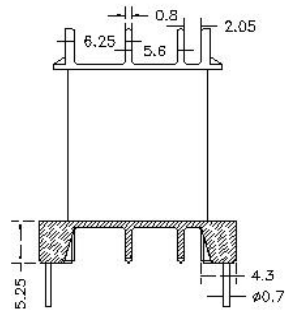
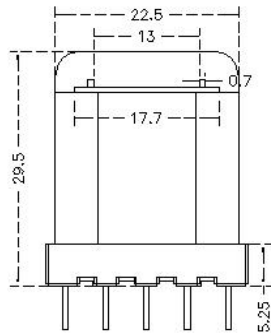

A-A

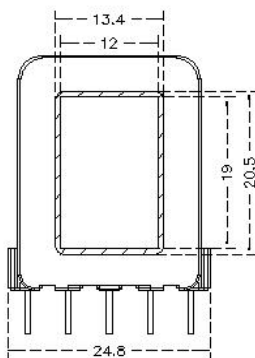
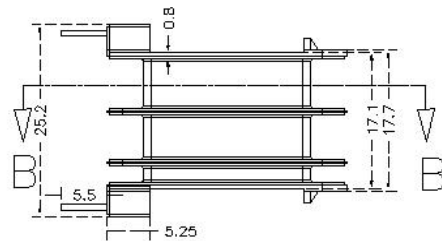
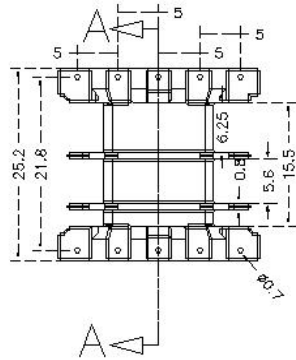

B-B

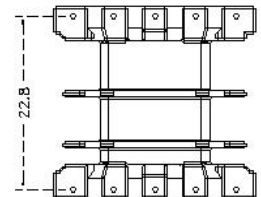
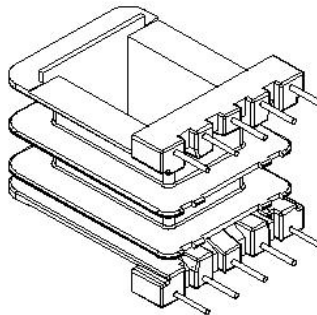

ANOTHER OPTION OF THE SPACE DISTANCE

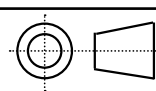
	Scale	Tolerance (mm)			Terminal Plating	Terminal Material	No of Terminals	
	None	0-4mm +/-0.1	4-16mm +/-0.2	16-60mm +/-0.3	100% Sn	CP Wire	10	



**LODESTONE PACIFIC**

**CHINA FACTORY**

[www.lodestonepacific.com](http://www.lodestonepacific.com)

Molding Material	UL File No.	Rating	Class
PBT	E59481	UL94-V0	B
<b>Bobbin Part Number</b>			Rev No
<b>B-EIM35X19H-10-3-PBT</b>			<b>1</b>