

Core Fit Reference

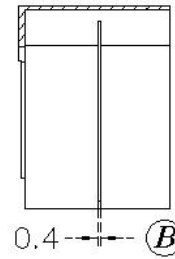

0690		EI-35	EI-37
		Metric	American

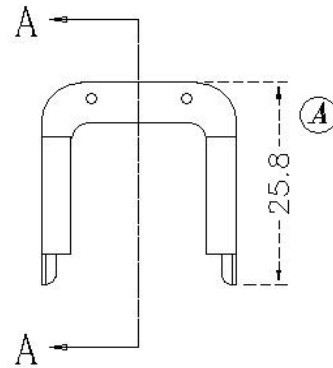
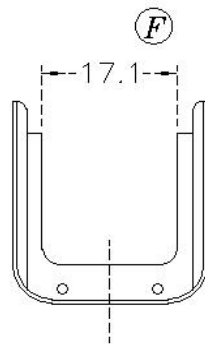
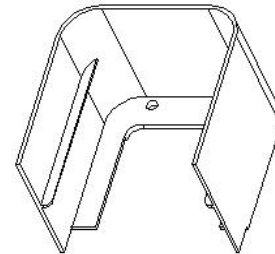
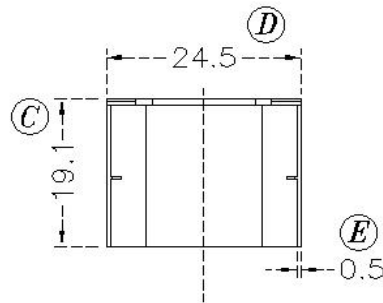

A-A

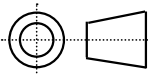

CAN BE USED WITH BOBBIN
 B-EIM35X12H-8-2-PBT-S

	Scale	Tolerance (mm)			Terminal Plating	Terminal Material	No of Terminals	
	None	0-4mm +/-0.1	4-16mm +/-0.2	16-60mm +/-0.3	100% Sn	CP Wire		
 <p>LODESTONE PACIFIC CHINA FACTORY www.lodestonepacific.com</p>					Molding Material	UL File No.	Rating	Class
					PBT	E59481	UL94-V0	B
					Bobbin Part Number			Rev No
BS-EIM35X12H-8-2-PBT			1					