

Core Fit Reference

0697

EI-96

EI-125

Metric

American

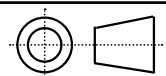
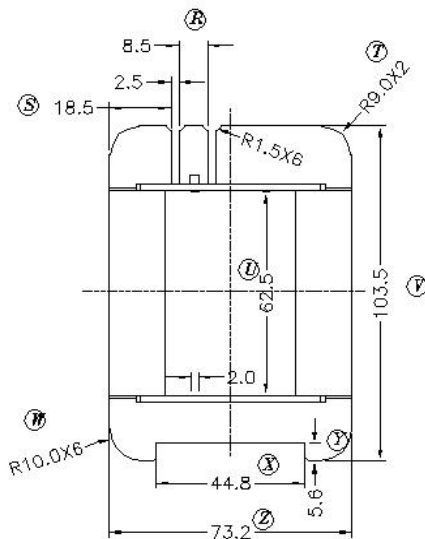
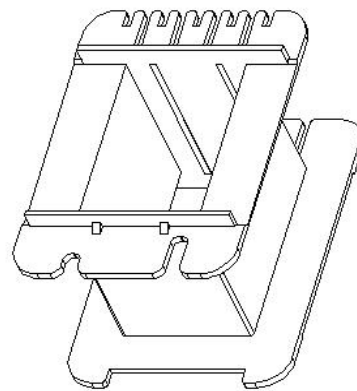
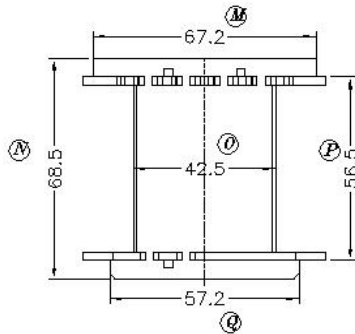
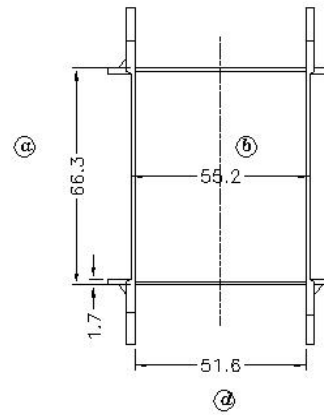
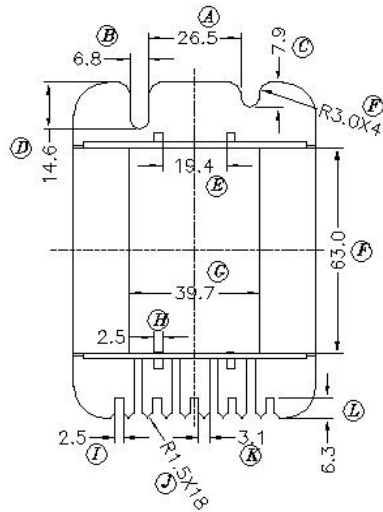

Scale	Tolerance (mm)		
None	0-4mm +/-0.1	4-16mm +/-0.2	16-60mm +/-0.3

Terminal Plating	Terminal Material	No of Terminals	
100% Sn	CP Wire		

Molding Material	UL File No.	Rating	Class
FR530	E41938	UL94-V0	N



Bobbin Part Number	Rev No
B-EIM96X114-1-PET	1