

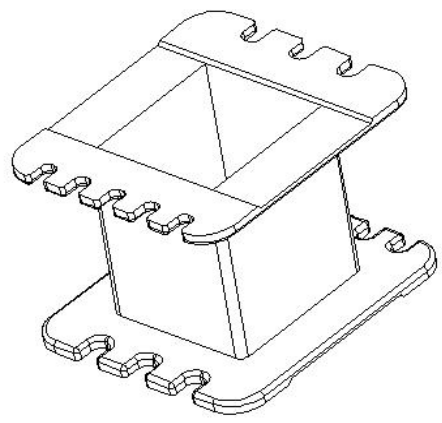

**Core Fit Reference**

<b>0330</b>		<b>EI-48</b>	<b>EI-62</b>
		<b>Metric</b>	<b>American</b>

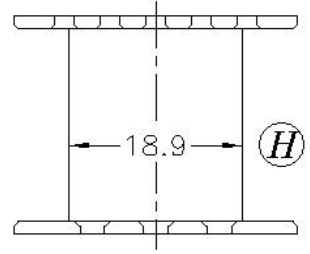
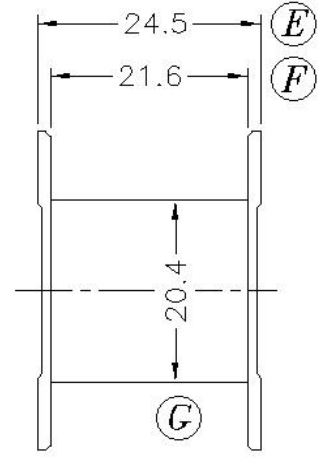
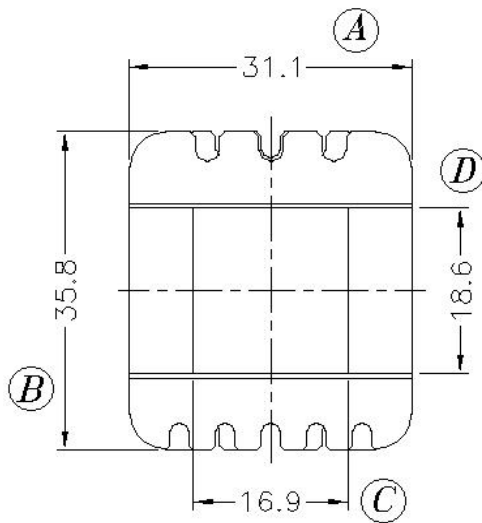

	Scale	Tolerance (mm)			Terminal Plating	Terminal Material	No of Terminals	
	None	0-4mm +/-0.1	4-16mm +/-0.2	16-60mm +/-0.3	100% Sn	CP Wire		

**LODESTONE PACIFIC**  
 **CHINA FACTORY**  
[www.lodestonepacific.com](http://www.lodestonepacific.com)

Molding Material	UL File No.	Rating	Class
FR50	E41938	UL94-V0	F
Bobbin Part Number			Rev No
B-EIM48X18-1-GFN			1