

Core Fit Reference

1050	EI-41	EI-50
	Metric	American

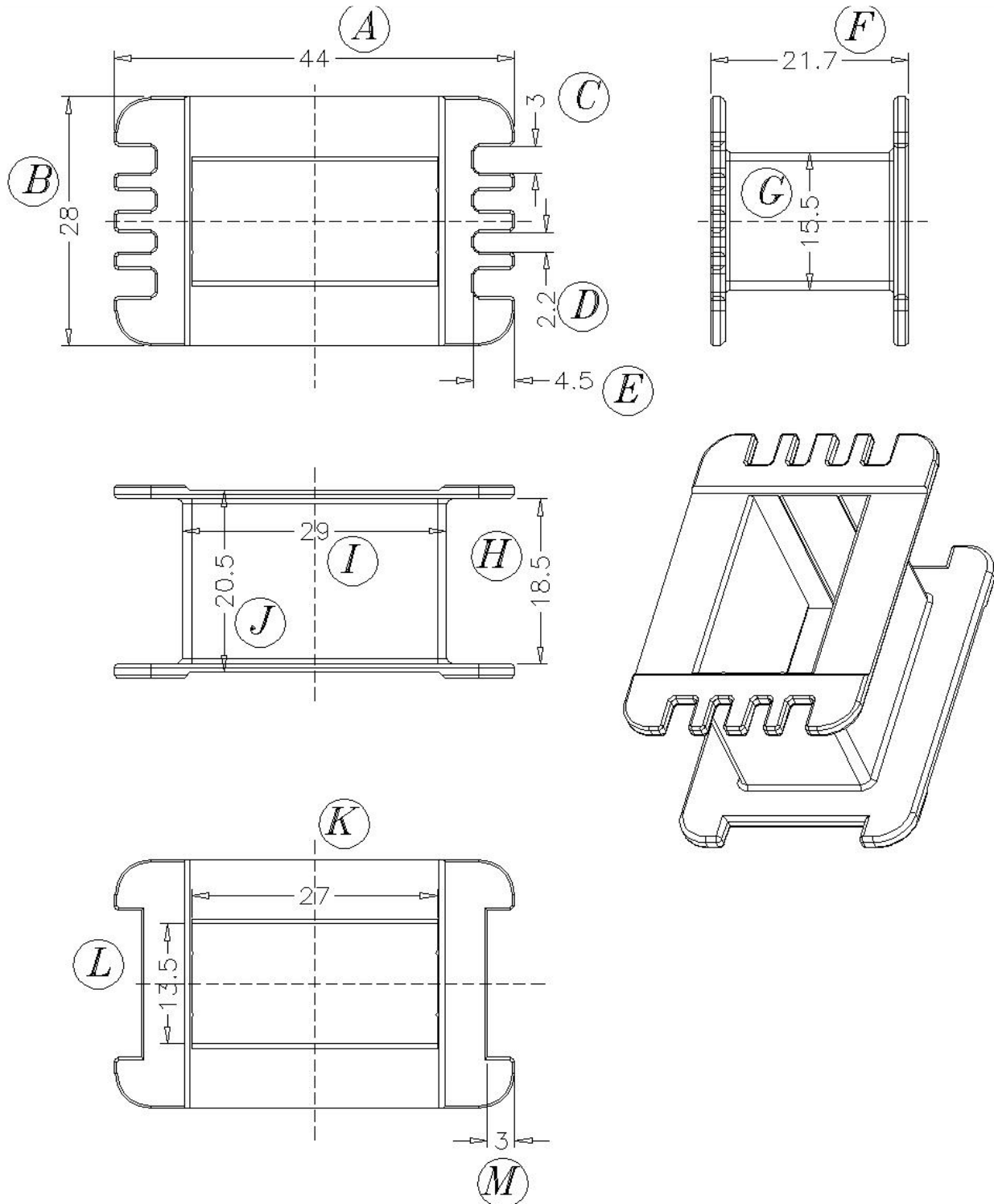
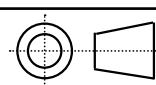

	Scale	Tolerance (mm)			Terminal Plating	Terminal Material	No of Terminals	
	None	0-4mm +/-0.1	4-16mm +/-0.2	16-60mm +/-0.3	100% Sn	CP Wire		

 LODESTONE PACIFIC CHINA FACTORY www.lodestonepacific.com	Molding Material	UL File No.	Rating	Class	
	FR50	E41938	UL94-V0	F	
	Bobbin Part Number				Rev No
	B-EIM41X27-1-GFN				1