

Core Fit Reference

0154		EI-41	EI-50
		Metric	American

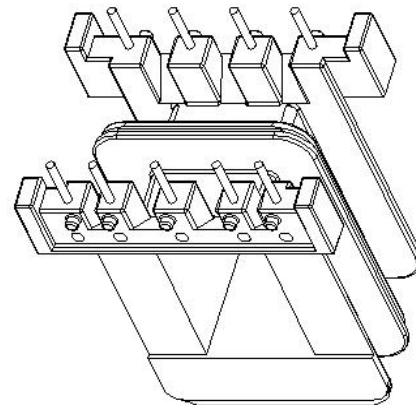
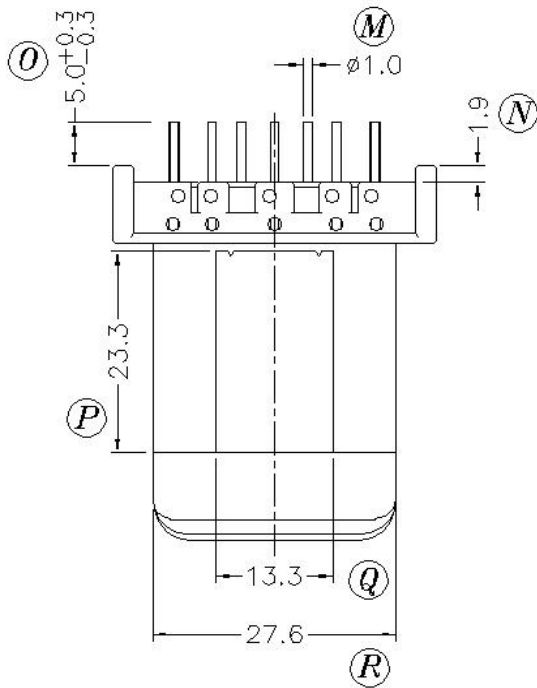
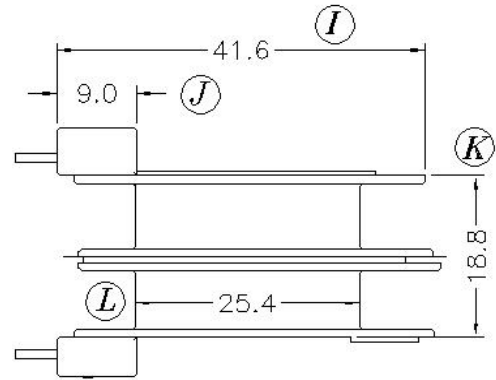
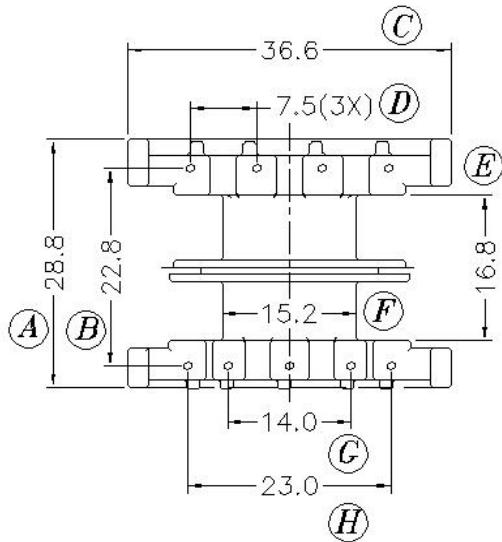
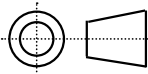

	Scale	Tolerance (mm)			Terminal Plating	Terminal Material	No of Terminals	
	None	0-4mm +/-0.1	4-16mm +/-0.2	16-60mm +/-0.3	100% Sn	CP Wire	9	

LODESTONE PACIFIC

CHINA FACTORY
www.lodestonepacific.com

Molding Material	UL File No.	Rating	Class
PBT	E59481	UL94-V0	B
Bobbin Part Number			Rev No
B-EIM41X23-1H-9-2-PBT-S			1