

Core Fit Reference

0115		EI-41	EI-50
		Metric	American

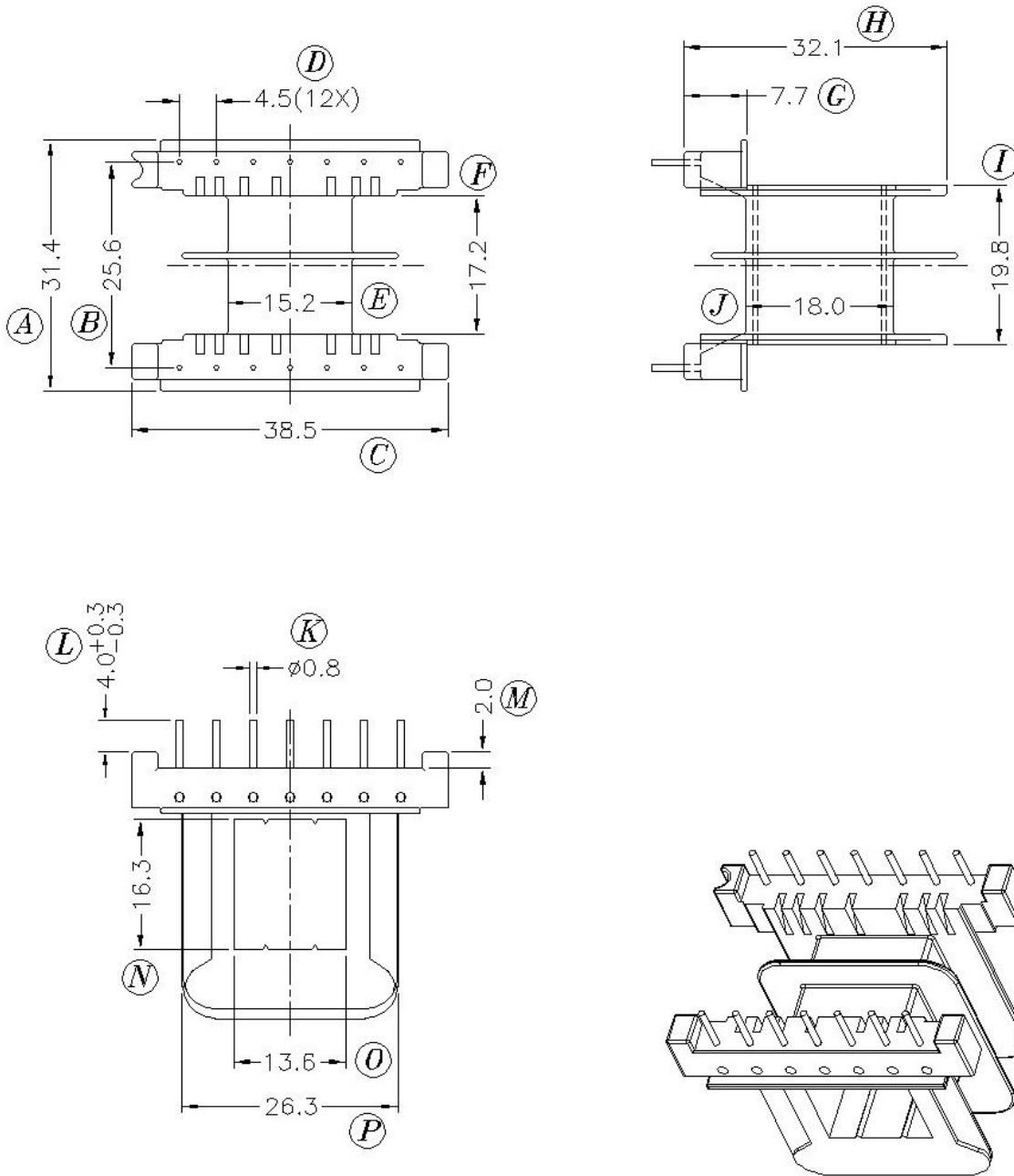
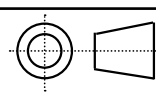

	Scale	Tolerance (mm)			Terminal Plating	Terminal Material	No of Terminals	
	None	0-4mm +/-0.1	4-16mm +/-0.2	16-60mm +/-0.3	100% Sn	CP Wire	14	

LODESTONE PACIFIC
 **CHINA FACTORY**
www.lodestonepacific.com

Molding Material	UL File No.	Rating	Class
FR530	E41938	UL94-V0	N
Bobbin Part Number			Rev No
B-EIM41X16-3H-14-2-PET			1