

**Core Fit Reference**

1430

EI-41  
Metric

EI-50  
American

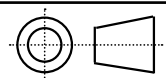
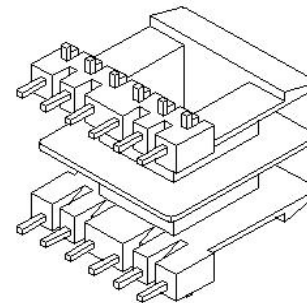
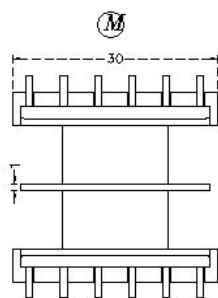
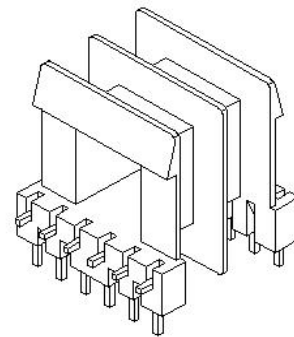
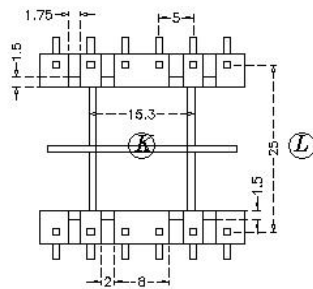
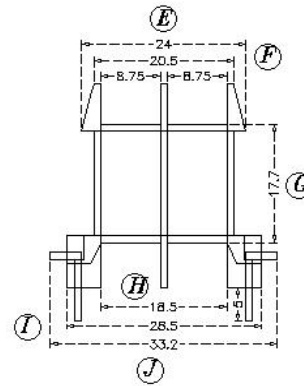
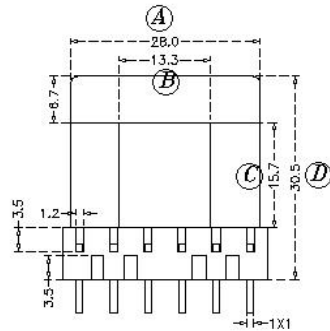

Scale	Tolerance (mm)			Terminal Plating	Terminal Material	No of Terminals	
None	0-4mm +/-0.1	4-16mm +/-0.2	16-60mm +/-0.3	100% Sn	CP Wire	12	

Molding Material	UL File No.	Rating	Class
FR50	E41938	UL94-V0	F
Bobbin Part Number			Rev No
B-EIM41X15.5H-12-2-GFN			1

