



Core Fit Reference

0081

EI-35  
Metric

EI-37  
American

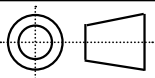
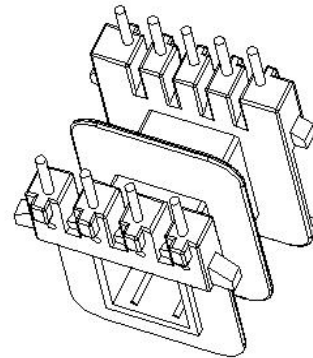
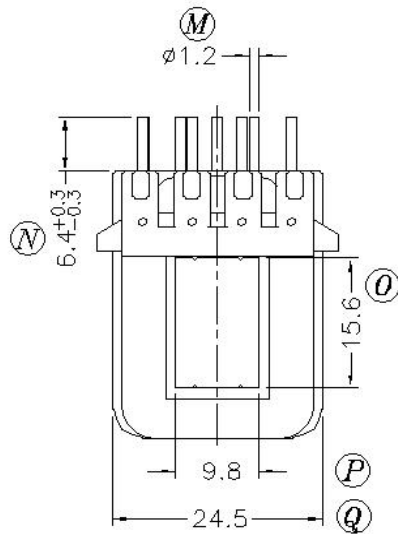
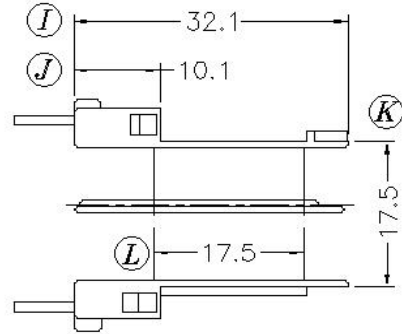
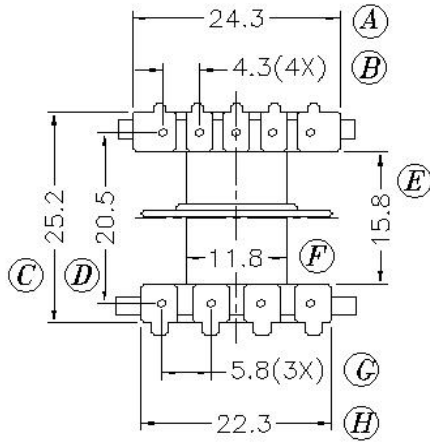

Scale	Tolerance (mm)		
None	0-4mm +/-0.1	4-16mm +/-0.2	16-60mm +/-0.3

Terminal Plating	Terminal Material	No of Terminals	
100% Sn	CP Wire	9	



Molding Material	UL File No.	Rating	Class
PBT	E59481	UL94-V0	B
Bobbin Part Number			Rev No
B-EIM35x15-2H-9-2-PBT			1