

1367

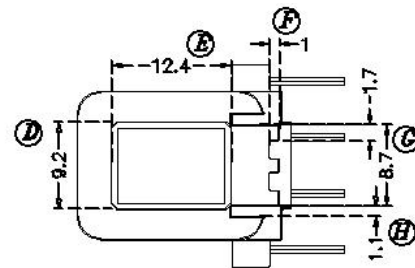

SECTION B-B

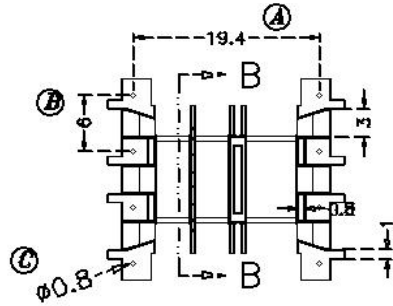
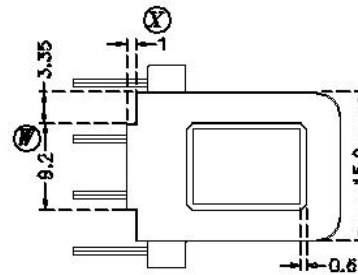
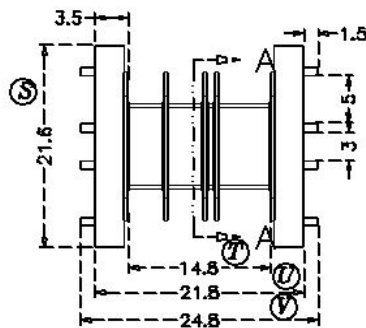
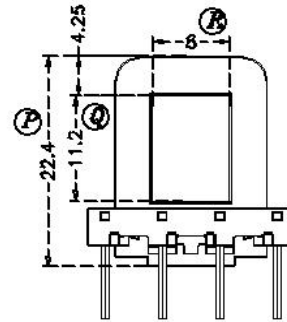
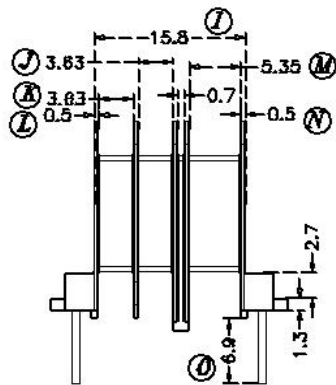

SECTION A-A

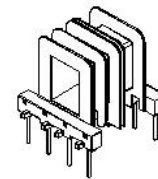
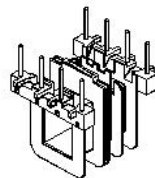

CAN BE USED WITH CASE
BC-EIM25X11H-8-3-PET

	Scale	Tolerance (mm)			Terminal Plating	Terminal Material	No of Terminals	
	None	0-4mm +/-0.1	4-16mm +/-0.2	16-60mm +/-0.3	100% Sn	CP Wire	8	



LODESTONE PACIFIC

CHINA FACTORY

www.lodestonepacific.com

Molding Material	UL File No.	Rating	Class
FR530	E41938	UL94-V0	N
Bobbin Part Number			Rev No
B-EIM25X11H-8-3-PET			1