

Core Fit Reference

0238		EI-150	EI-175
		Metric	American

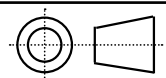

Scale	Tolerance (mm)			Terminal Plating	Terminal Material	No of Terminals	
None	0-4mm +/-0.1	4-16mm +/-0.2	16-60mm +/-0.3	100% Sn	CP Wire		

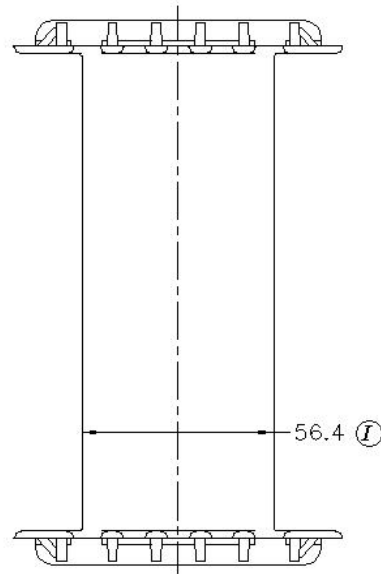
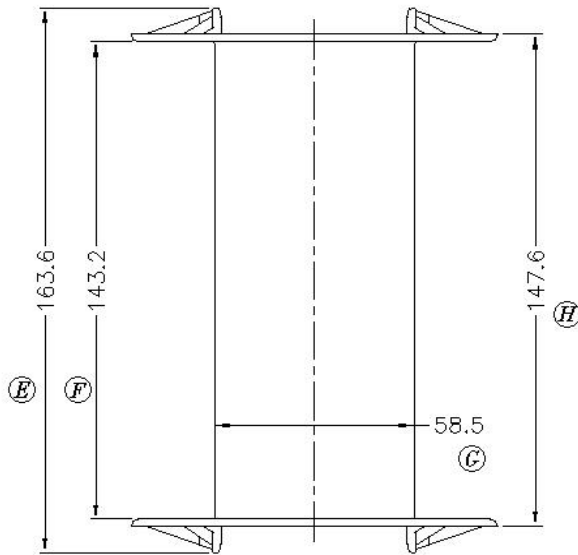
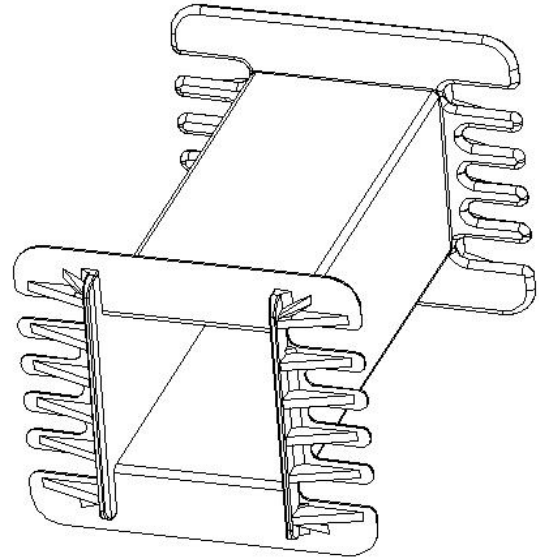
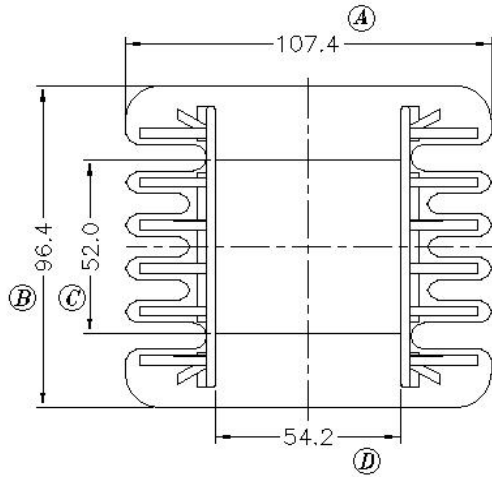

LODESTONE PACIFIC

CHINA FACTORY

www.lodestonepacific.com

Molding Material	UL File No.	Rating	Class
FR530	E41938	UL94-V0	N
Bobbin Part Number			Rev No
B-EIM150X54-1-PET			1